

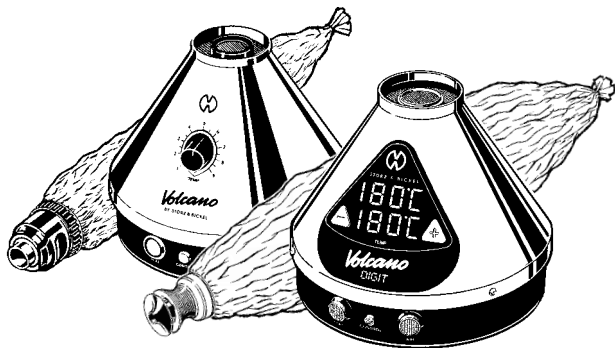

STORZ & BICKEL GMBH & CO. KG



Volcano[®]
VAPORIZATION SYSTEM

INSTRUCTIONS FOR USE

Read carefully before using the device
and save these instructions.

Table of Contents	page
1. Product Overview, Service	6
2. Explanation of Symbols, Safety Recommendations	8
2.1. Explanation of Symbols	9
2.2. Safety Recommendations	10
3. Intended Use	12
4. Overview of Plants	12
5. Factors Influencing Vaporization	14
5.1. Breathing Techniques	15
6. The Hot Air Generators VOLCANO DIGIT and VOLCANO CLASSIC	16
6.1. Unpacking	16
6.2. Installation	16
6.3. Application and Operation	16
6.4. Care and Maintenance	16
6.5. Storage	17
6.6. In Case of Problems	17
6.7. Troubleshooting	18
7. VOLCANO DIGIT	20
7.1. Installation	20
7.2. Heating Up	20
7.3. Temperature Setting	21

Table of Contents	page
8. VOLCANO CLASSIC	22
8.1. Installation	22
8.2. Heating Up	22
8.3. Temperature Setting	22
9. EASY VALVE	23
9.1. Application and Operation	23
9.2. Cleaning and Maintenance	26
9.3. Accessories	29
9.3.1. Filling Chamber Reducer	29
9.3.2. Dosing Capsules and Magazine	30
9.3.3. Disposable Lip Piece for Hygienic Use	32
10. SOLID VALVE	34
10.1. Application and Operation	38
10.2. Cleaning and Maintenance	38
11. Attachment of the Balloon to the EASY VALVE with Balloon Adapter resp. SOLID VALVE	43
12. Drip Pad	45
12.1. Preparation	45
12.2. Application	45
12.3. Cleaning	46
13. Technical Specifications	47
14. CE Declaration of Conformity	47
15. Warranty, Liability, Repair Service	48
15.1. Warranty	48
15.2. Liability	48
15.3. Repair Service	49
15.4. Copyright	49

1. PRODUCT OVERVIEW SOLID VALVE

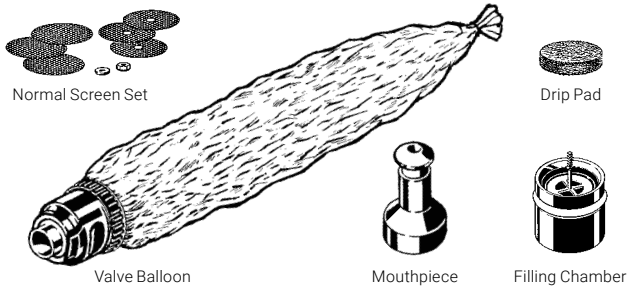

Compatible with VOLCANO CLASSIC and VOLCANO DIGIT

1. PRODUCT OVERVIEW EASY VALVE

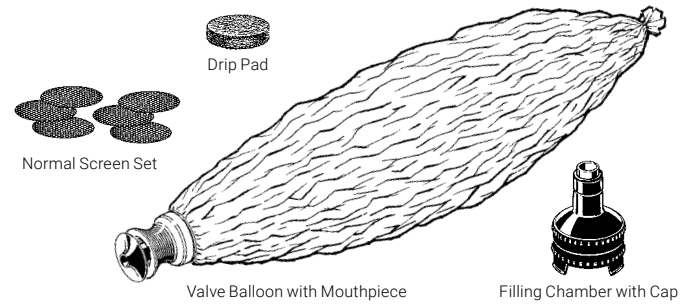

Compatible with VOLCANO CLASSIC and VOLCANO DIGIT

1. PRODUCT OVERVIEW VOLCANO CLASSIC

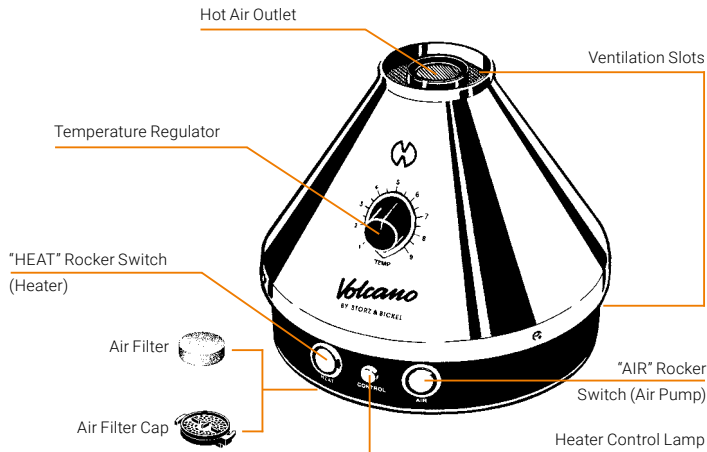

1. PRODUCT OVERVIEW VOLCANO DIGIT

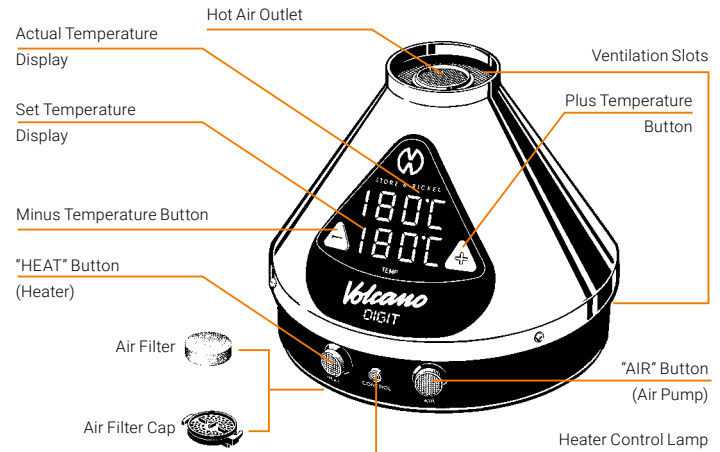

1. SERVICE

Please check whether all components have been included. If not, please inform the Storz & Bickel Service Center.

In the case of technical problems, questions about the device, repairs, warranty claims and disposal of the device, customers in the US and Canada should contact the following address:

Storz & Bickel America, Inc.
1078 60th Street, Suite A
Oakland, CA 94608

All other customers should contact the following address:

Storz & Bickel GmbH & Co. KG
In Grubenäcker 5-9
78532 Tuttlingen, Germany

2. SAFETY RECOMMENDATIONS



Read the following safety recommendations thoroughly and carefully before using the device.

These Instructions for Use are a significant part of the VOLCANO Vaporization System and must be provided to the user. The instructions given in these Instructions for Use must be strictly observed as they are ex-

tremely important to ensure safety during installation, use and maintenance of the VOLCANO Vaporization System.

Please keep this brochure in a safe place for future reference. You may download the current Instructions for Use for the VOLCANO Vaporization System on www.storz-bickel.com.

2. EXPLANATION OF SYMBOLS

2.1. Explanation of Symbols



Please follow these instructions carefully!



EU conformity symbol:
The manufacturer confirms with this symbol the compliance of the product with the applicable European directives and standards.



Caution! Hot surfaces!

Never leave Filling Chamber on VOLCANO Hot Air Generator.



Safety recommendations!

In order to avoid injuries to persons and damage to the equipment, it is mandatory to observe instructions marked with this symbol.



Note/Tip!

This symbol always gives you technical information or useful tips regarding the VOLCANO Vaporization System.



Protect from direct sunlight.



The device was introduced after 13 August 2005. It may not be disposed of in normal household waste. The X on the trash can indicates the necessity of disposing of this product separately.



Protect against moisture and humidity.



Safety tested and production monitored by TUEV SÜED according to EN 60335-1, UL 499 and CAN/CSA-22.2 No. 64-M91.



Symbol for the manufacturer - the manufacturer's name and address are next to the symbol

2. SAFETY RECOMMENDATIONS

2.2. Safety Recommendations

- ▶ The packing material (plastic bags, styrofoam material, boxes etc.) must be kept out of the reach of children as it is a potential source of danger.
- ▶ People who require assistance must be supervised constantly during application. Such persons often underestimate the hazards involved (e.g. strangulation with the power cord), thus resulting in a risk of injury.
- ▶ The device contains small parts which can block the respiratory tract and lead to choking. Therefore, make sure that you always keep the Hot Air Generator and accessories out of the reach of babies and infants.
- ▶ Before connecting the Hot Air Generator, make sure that the information given on the type label on the underside of the Hot Air Generator corresponds to the mains supply at the place of installation.
- ▶ If there are any problems during operation, immediately pull out the power plug from the socket.
- ▶ The power cord must be unwound over its entire length (avoid rolling up the power cord and overlapping the cord). It must not be exposed to any impacts and must be kept out of the reach of children. Also, it must not be kept near liquids or sources of heat and must not be damaged. Do not wind the power cable tightly, nor pull it over sharp edges and never crush or kink it. If the power cord is damaged, please contact our Service Center to have it replaced. Never try to repair a power cable yourself!
- ▶ The use of multiple sockets and/or extension cables is not recommended. However, if this is absolutely necessary, only products with a quality certificate (such as UL, IMQ, VDE, +S etc.) may be used, provided the specified power exceeds the power required (A = Ampere) by the devices that are connected.
- ▶ If you have any concerns, ask a specialist to check whether the electrical system is in accordance with the local safety regulations.
- ▶ Install the Hot Air Generator on a stable and dry surface at a sufficient distance from sources of heat (oven, stove, fireplace etc.) and in a place where the ambient temperature cannot drop below +5°C (+41°F). Store the Hot Air Generator in a dry place protected against the effects of weather and out of the reach of children or unqualified persons. It cannot be used in damp locations (such as bathrooms etc.).
- ▶ Do not operate the Hot Air Generator close to flammable objects such as curtains, tablecloths, or paper.
- ▶ Keep the Hot Air Generator away from pets (e.g. hamsters, mice) and other animals which could damage the insulation of the mains adapter cord.
- ▶ The Hot Air Generator may only be repaired by our Service Center.

2. SAFETY RECOMMENDATIONS

- ▶ In-correctly performed repairs with out the use of original spare parts can prove dangerous to the user.
- ▶ Danger to life when opening the Hot Air Generator as live components and connections are exposed.
- ▶ The Hot Air Generator must never be repaired or transported when the power plug is plugged in.
- ▶ To pull the power plug from the socket, pull the power plug directly, never pull the power cord.
- ▶ The Hot Air Generator must never be operated when the power cord is faulty.
- ▶ Do not put any objects into the openings of the device.
- ▶ Do not leave the Vaporizer unattended during operation. After use, switch off the heater and the air pump.
- ▶ The ventilation slots as well as the hot air outlet of the Hot Air Generator must not be closed, obstructed or blocked while the device is being used, nor while it is cooling down.
Caution! Hot surface!
- ▶ When they are hot do not touch the hot air outlet and the Filling Chamber.
- ▶ The Filling Chamber may only be placed on the hot air outlet while filling the Valve Balloon. After filling the Valve Balloon the Filling Chamber must be removed from the Hot Air Generator in order to avoid over-heating of the Filling Chamber. (Caution! Hot surface!)
- ▶ Do not put any body parts or objects in the hot air jet.
- ▶ Before cleaning, remove the power cord from the socket. The Hot Air Generator should be cleaned only with a dry cloth - or a damp cloth if absolutely necessary. Never immerse the Hot Air Generator in water or in other liquid, nor clean it with direct jets of water or steam.
- ▶ The Hot Air Generator must not be used in damp or wet conditions.
- ▶ Do not expose the Hot Air Generator to rain. Do not use in the bathroom or above water.
- ▶ Never touch the Hot Air Generator with wet or damp parts of the body.
- ▶ Never put containers containing liquids on the Hot Air Generator.
- ▶ Never operate the Hot Air Generator when it is wet or damp. If the Hot Air Generator gets wet, it must be checked by our Service Center for damage to electrical components.
- ▶ Do not use in an atmosphere with risk of explosion or ignition.
- ▶ Never allow the Vaporizer to be used by children or unqualified persons.
- ▶ Only use original Storz & Bickel accessories and spare parts.



The manufacturer is not responsible for any damage or personal injury caused by inappropriate, incorrect or irresponsible use.

3. INTENDED USE

The VOLCANO Vaporization System releases fragrances or aromas from the herbs and other plant materials listed below, or from their extracts (aromatic oils). These aromatic substances are released through vaporization by heated air, and may be exhausted directly into the ambient air, or collected in a Valve Balloon for subsequent inhalation.

The device may only be used with the recommended vaporizing media. The use of other substances can present a health risk.

The VOLCANO Vaporization System is not FDA approved.

4. OVERVIEW OF PLANTS

Below is an overview of the plants that are suitable for vaporization in the VOLCANO. The aromas and fragrances from the plant materials listed below may be vaporized.

Any other use is inappropriate and potentially dangerous.

The VOLCANO Vaporization System is not FDA approved.

Plant name	Botanical name	Portion of the plant used	Temperature setting
Eucalyptus	Eucalyptus globulus	the leaves	1 / 130°C (266°F)
Hops	Humulus lupulus	the cones	3 / 154°C (309°F)
Chamomile	Matriarca chamomilla	the blossoms	6 / 190°C (374°F)
Lavender	Lavandula angustifolia	the blossoms	1 / 130°C (266°F)
Lemon balm	Melissa officinalis	the leaves	2 / 142°C (288°F)
Sage	Salvia officinalis	the leaves	6 / 190°C (374°F)
Thyme	Thymus vulgaris	the herb	6 / 190°C (374°F)

4. OVERVIEW OF PLANTS

The extracts (aromatic oils) of these plants can be vaporized at up to 130°C (266°F) with the help of the Drip Pad supplied with the Vaporizer. To do so, please follow the instructions given in Chapter 12. "Drip Pad", page 45.



WARNING: Please consult your doctor or pharmacist if you have any medical concerns. It is possible that some plants may cause allergic reactions for the user. If this occurs, it is urgently recommended to refrain from further use of such plants. Only use the plant parts which are found in this list and which have been verified according to the regulations of the European or any other pharmacopoeia with regard to genuineness, purity and pathogenic germs. You can purchase such plants or plant parts in pharmacies.

It is important to observe the following instructions in order to set the VOLCANO Vaporization System with the plant material in the best possible way for your personal requirements.

5. FACTORS INFLUENCING VAPORIZATION

The amount of aromas and fragrances released into the Valve Balloon can be influenced by the following factors:

1. **Quality:** The amount of aromas or fragrances contained in the respective plant material that can be vaporized.
2. **Quantity:** The amount of vaporization material in the Filling Chamber.
3. **Surface:** The finer the plant is ground, the greater the surface and the more aromas and fragrances can be released during the vaporization cycle.
4. **Temperature:** The higher the temperatures, the more aromas and fragrances will be released at once.

Please note: Increasing the temperature should be the last resort, because plant material tastes more toasted when using higher temperature.

Since the plant ingredients are released in a gentle manner, the vaporization cycle may be repeated with the same contents in the Filling Chamber. Depending on the four factors described above, the load of the Filling Chamber may be reused multiple times until the aromas and fragrances are released completely. It is advised to take out the content of the Filling Chamber and grind it once again to increase the surface of the original material. An increased temperature would activate more vapor as well, but has a negative effect on the taste. If no more vapors are visible at the highest

temperature, then the vaporization material is completely exhausted and must be replaced with new material. However, for the best aroma results it is advisable to replace the vaporization material before this point.

It is important to watch the vapor density in the Valve Balloon. A fine, white vapor feels very comfortable when inhaled. As the vapor gets denser the taste can get too strong. A very high intensity (density) of the vapor can lead to irritation of the respiratory passages from the concentration of the aromas and fragrances. In this case, the temperature should be lowered, so that the intensity of the vapors is reduced.

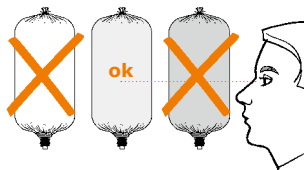

Watch vapor density

5. FACTORS INFLUENCING VAPORIZATION

It is not necessary to fill the Valve Balloon completely. It is often sufficient to fill only half or even less than half of the Valve Balloon in order to achieve the desired results.

The Valve Balloon is not suitable for storing vapors over a long period because the vapors condense on the Valve Balloon Jacket over time (a few hours). Only fill the amount you want to inhale within 10 minutes.

5.1. Breathing Techniques



The device is not to be used, if the user has respiratory tract or lung conditions. Depending on the density, the vapor could irritate respiratory tracts or lungs, which can lead to coughing.

Inhale only half the amount of air you can normally manage. Hold your breath for a few seconds and then exhale slowly. It is advisable to deliberately concentrate on your breathing process.

6. VOLCANO DIGIT AND CLASSIC HOT AIR GENERATORS

6.1. Unpacking

The box contains all components as well as the Instructions for Use. Keep the Instructions for Use for future reference.

Take out the Hot Air Generator and the accessories from the box. Immediately after unpacking check whether the Hot Air Generator, the accessories, the power cord and the power plug are all included in the delivery and work properly. If you notice any defects, inform the seller or the delivery agent immediately.



The packing material (plastic bags, styrofoam material, boxes etc.) must be kept out of the reach of children as it is a potential source of danger.

Please dispose of the packing material in a proper and environmentally friendly manner.

We recommend keeping the original packaging in case it is required later (transport, Storz & Bickel Service Center etc.).

6.2. Installation

Before installing the Hot Air Generator, make sure that the information given on the type label on the underside of the device corresponds to the local mains supply data. All parts of the electrical system must comply with currently applicable official regulations. Put the Hot Air Generator on a flat and stable surface.

Take care that the power cord cannot be damaged through kinking, crushing or pulling.



Improper installation may lead to personal injury or material damages, for which the manufacturer cannot be held responsible.

6.3. Application and Operation



This Hot Air Generator was developed for vaporizing the plant materials listed in the plant overview as well as their extracts. Any other use is inappropriate and potentially dangerous.

For use and maintenance, the user must always follow the instructions given in these Instructions for Use.

If you have any concerns, or if there are any problems immediately switch off the Hot Air Generator and pull out the power plug from the socket. Do not try to remedy the defect yourself. Contact our Service Center directly.

Allow the device to cool down before it is packed away.

6.4. Care and Maintenance

Before any maintenance work is done, the device has to be switched off and the power plug has to be unplugged from the power supply.

6. VOLCANO DIGIT AND CLASSIC HOT AIR GENERATORS

At the bottom of the Hot Air Generator is an Air Filter. The Air Filter must be inspected for contamination every four weeks by turning the Air Filter Cap counterclockwise and remove the Air Filter.

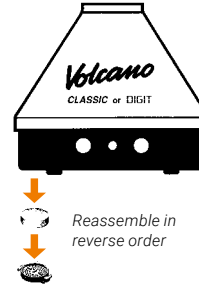

Only clean the device with a damp cloth when dirty. Please do not use any hard or abrasive implements, such as steel wool, metal brushes, needles, inappropriate plastic sponges, etc., nor any aggressive cleaning agents.

Clean the housing with a soft cloth; or, if need be, use a mild cleaning agent (soap water).

6.5. Storage

Store the Hot Air Generator in a dry place protected against the effects of weather and out of the reach of children or unqualified persons.

6.6. In Case of Problems

Immediately unplug the power cord and ensure that no one can connect the Hot Air Generator to the mains supply again without this being noticed.

If there are any faults in the electronics of VOLCANO DIGIT, you can perform a reset by pulling out the power plug and plugging it again after waiting for a minimum of three seconds.

Put the Hot Air Generator in the original packaging, or pack it properly in other packing material, and take it to our Service Center.

If the Hot Air Generator is irreparably damaged, please do not simply throw it away. As it is made of high quality, completely recyclable component parts, it should be brought to a material recycling center in your town or sent to our Service Center for disposal.

6. VOLCANO DIGIT AND CLASSIC HOT AIR GENERATORS

6.7. Troubleshooting

If the device does not function properly when the power plug is connected to the power socket, please check the Hot Air Generator using the tips in the following table:

Problem	Possible Cause / Remedy
No green light signal visible on the display of the VOLCANO; no activation of the heater or pump possible.	Please make sure that the current is on and that the fuse (in the mains fuse box) is switched on and is not defective. If the Hot Air Generator still does not function, the internal fuses may have been triggered. In this case, send the VOLCANO Hot Air Generator to our Service Center.
No aerosol is formed.	Check the set and actual temperature. Make sure the Filling Chamber and/or Valve Balloon were correctly attached. Check whether an extract (aromatic oil) has been added to the Drip Pad or whether there is fresh, unused plant material in the Filling Chamber.
The Valve Balloon does not fill up.	Check whether the pump is turned on. Check whether the Filling Chamber and/or Valve Balloon are correctly attached.
The device switches off (automatic switch-off of the VOLCANO DIGIT).	No button was pressed in the last 30 minutes – this leads to automatic switch-off. Switch heater or pump on again.
Plant particles in the Valve Balloon (when using plant material).	Check whether the Screen in the Filling Chamber Cap is clogged or is not inserted into the notch properly. Check whether the Filling Chamber was cleaned according to the Instructions for Use.

6. VOLCANO DIGIT AND CLASSIC HOT AIR GENERATORS



If the preceding tips do not yield the desired results, or for any other defects or problems not mentioned here, please unplug the power plug and contact our Service Center immediately.



Do not open the Hot Air Generator! Without special tools and specialized knowledge, any attempt to open the device will cause damage to it. Such an attempt will invalidate the warranty claim.

Do not try to remedy the defect yourself. Contact our Service Center directly.

7. VOLCANO DIGIT

7.1. Commissioning



Do not leave the device unattended during operation. Put the VOLCANO DIGIT on a flat and stable surface.

Check whether the mains voltage corresponds to the voltage rating stated on the device. The power cord and the power plug must be in perfect condition. Only connect the VOLCANO DIGIT to a properly installed (grounded) socket.

It is mandatory to electrically ground the Hot Air Generator. The manufacturer will not bear any responsibility whatsoever if this accident prevention measure is not taken.

When the power plug is plugged in, the LED display of the device lights up briefly. At the same time, an internal software query is performed.

The green dot on the display shows that the Hot Air Generator is connected to the mains supply.

7.2. Heating Up

To switch on the heater, push the button labeled "HEAT". The set/actual temperature will light up, signaling that the heater is switched on.

At the same time, the yellow control lamp will light up to indicate that the device is heating up.

The upper, red display shows the actual temperature in the Filling Chamber with the air pump switched on, and the lower, green display shows the desired set temperature. The heating process is completed when the set value is equal to the actual value. The heating process can take up to 5 minutes depending upon the chosen temperature. After the heating process is completed, the temperature is constantly maintained at the set value. The luminous intensity of the yellow control lamp corresponds to the intensity of the heating process.



For technical reasons the temperature in the Filling Chamber cannot be measured during vaporization. During operation the temperature is measured at the heat exchanger. The display indicates the reference values for the attached Filling Chamber with the air pump switched on.

7. VOLCANO DIGIT

7.3. Temperature Setting

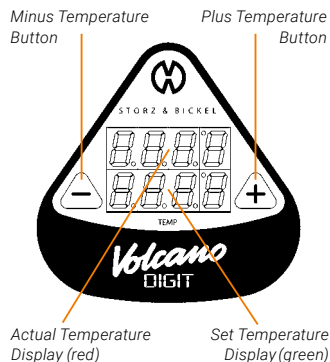

When you press the plus button, the set value is increased, and when you press the minus button, the set value is decreased. When you briefly tap on the plus or minus button, the set values are increased or decreased respectively in 1-degree increments. If you keep the plus or minus button pressed, the set values start running continuously in the corresponding direction. If you simultaneously tap on the plus button and the minus button, the display changes from degree Celsius to degree Fahrenheit and vice versa.



If the actual value is higher than the set value, you can speed up the cool off process by switching on the air pump.



30 minutes after the last time a button is pressed, the device automatically switches off.

As long as the heater has a substantial amount of residual warmth, the temperature is displayed until it drops below +40°C (+104°F). Then the display turns off, and the green dot on the display indicates that the Hot Air Generator is connected to the mains supply.

8. VOLCANO CLASSIC

8.1. Commissioning



Do not leave the device unattended during operation. Put the VOLCANO CLASSIC on a flat and stable surface. Check whether the mains voltage corresponds to the voltage rating stated on the device. The power cord and the plug must be in a perfect condition. Only connect the VOLCANO CLASSIC to a properly installed (grounded) socket.

It is mandatory to electrically ground the Hot Air Generator. The manufacturer will not bear any responsibility whatsoever if this accident prevention measure is not taken.

8.2. Heating Up

To switch on the heater, push the rocker switch labeled "HEAT". The rocker switch will light up signaling that the heater is in operation. At the same time, the yellow control lamp will be signaling that the device is heating up. This heating process of the heat exchanger can take up to 5 minutes depending upon the chosen temperature.

As soon as the yellow control lamp turns off, the set temperature has been reached, and the heat exchanger's warming process is complete. If the temperature in the heat exchanger drops, the heat exchanger will automatically heat up, which is signaled by the yellow control lamp lighting up again.

8.3. Temperature Setting

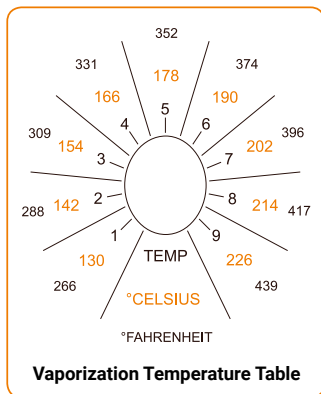

The vaporization temperature may fluctuate about $\pm 5^\circ\text{C}$ ($\pm 9^\circ\text{F}$) related to the indicated values because of the heating and cool off process of the heat exchanger. For example at level 6 from 185°C up to 195°C (365°F up to 383°F).

Select the desired temperature at the temperature regulator knob.



Select temperature

9. EASY VALVE

9.1. Application and Operation

Turn the Filling Chamber Cap counter-clockwise in order to remove it from the Filling Chamber.

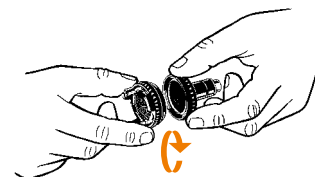

Remove Filling Chamber Cap

Fill the desired amount of ground plant material in the Filling Chamber.



Fill Filling Chamber

Next screw on the Filling Chamber Cap again.



Screw on Filling Chamber Cap



Take care that the Screens are not obstructed with plant material. To guarantee optimal results, we recommend cleaning the Screens after each vaporization cycle with the enclosed Cleaning Brush.

Put the Filling Chamber with Cap on the hot air outlet of the Hot Air Generator and allow it to lock in place. Switch on the air pump. To do so, press the green button/switch labeled "AIR". The Filling Chamber as well as the vaporization material must be preheated for a couple of seconds before the aromas and fragrances start to vaporize. Before attaching, remove the Mouthpiece from the Valve Balloon.

approx. 5 sec



Preheat plant material for a few seconds



Before putting the Valve Balloon on the Filling Chamber, stretch it tight so that the Balloon is placed vertically on the Hot Air Generator when it is filled.

9. EASY VALVE

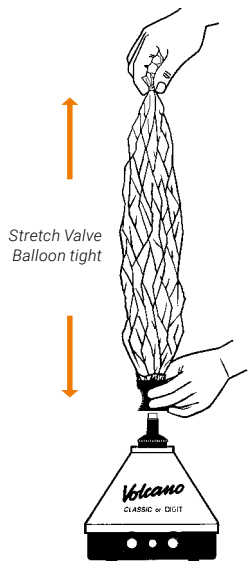

Put the Valve Balloon on the Filling Chamber and allow it to lock in place. This will open the Valve. Now the Valve Balloon will fill with vapor.

Only fill the Valve Balloon with the approximate amount of vapor that you intend to use within the next 10 minutes. Do not overfill the Valve Balloon (overpressure) in order to prevent the loss of vapor. It is important to watch the vapor density in the Valve Balloon (see Chapter 5. "Factors influencing vaporization", page 14).

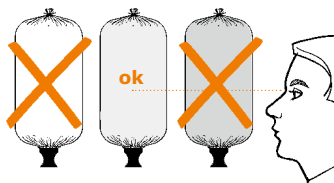

When the Valve Balloon is filled, switch off the air pump and remove the Valve Balloon with Filling Chamber. To do so, hold the Filling Chamber Cap at the textured grip.

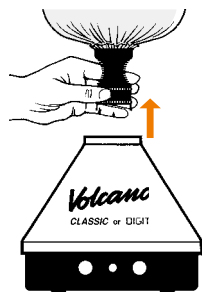

Remove Valve Balloon with Filling Chamber



Caution! Hot surface!



Do not touch any components of the Filling Chamber (except at the textured grip) until they have cooled down after the Valve Balloon has been filled.

9. EASY VALVE



Caution! Hot surface!

Never leave Filling Chamber on VOLCANO

Never leave the Filling Chamber on top of the hot air outlet of the VOLCANO as long as the heater is on, except when filling the Valve Balloon. Non-observation can lead to an overheated Filling Chamber, which might burn one's fingers.

Detach the Valve Balloon from the Filling Chamber. When you do so, the Valve is automatically closed so that the vapors in the Valve Balloon cannot escape.

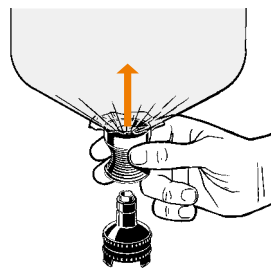

Detach Valve Balloon from Filling Chamber

Attach the Mouthpiece to the Valve and allow it to lock in place.

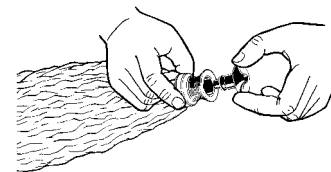

Attach the Mouthpiece to the Valve Balloon

To inhale, put the Mouthpiece to your lips and press them lightly against the Mouthpiece. By doing so, the Valve opens and the vapors can be inhaled from the Valve Balloon. As soon as you remove the pressure from the Mouthpiece, the Valve automatically closes.

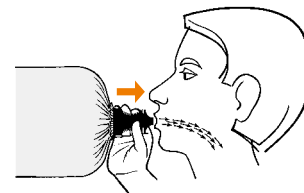

Press Mouthpiece against lips and inhale slowly and evenly for several seconds

9. EASY VALVE

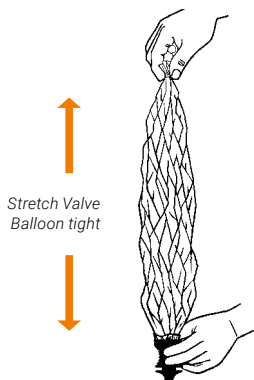

! As the content of the Valve Balloon deflates, it may be completely emptied by stretching the Balloon taut and subsequently inhaling the content.

9.2. Cleaning and Maintenance

EASY VALVE Balloon with Mouthpiece

The EASY VALVE Balloon and its Mouthpiece require no maintenance. For hygienic reasons, they should be replaced with a new Valve Balloon and Mouthpiece every two weeks. To prevent any transfer of infectious germs, the Valve Balloon and Mouthpiece should be used only by one person, and never shared by multiple individuals.

Filling Chamber with Filling Chamber Cap

Please allow the Filling Chamber and the Cap to cool down before disassembling them. The component parts of the Filling Chamber must be thoroughly cleaned on a regular basis to guarantee proper operation and pure flavor. For hygienic reasons, it is also necessary to clean the Filling Chamber with Cap for hygienic reasons when the device is to be used by a different person. If a new Valve Balloon and Mouthpiece are used, the Filling Chamber should also be cleaned beforehand. For manual cleaning, use rubbing alcohol and paper or cotton towels or warm water with wash-up liquid. Filling Chamber and Cap may be easily disassembled and reassembled for cleaning in a few seconds. Filling Chamber and Cap Components may also be cleaned in a dishwasher. However, the Screens, Cap Ring and Filling Chamber Clips are very small, and may be lost if placed in a dishwasher. Before assembling allow all component parts to dry properly.

9. EASY VALVE

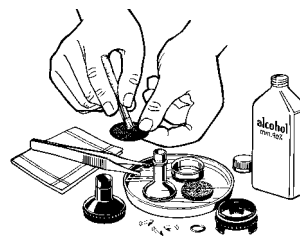

Manual cleaning with alcohol (min. 90%)

! Do not immerse any plastic components in ethanol or alcohol for longer than an hour. Extended contact with ethanol or alcohol may lead to discoloration or embrittlement of plastic parts.

After cleaning, check all component parts for surface damage, tears, softening or hardening, impurities, distortion and discoloration and set damaged component parts aside.

Disassembling the Filling Chamber Cap

Push the upper Screen downwards, by using (for example) the handle of the Cleaning Brush supplied.

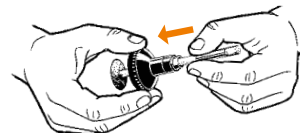

Push out the upper Screen with help of the Cleaning Brush

Push the Cap Cylinder downwards out of the Cap Housing. At the same time the Cap Ring will be stripped off.

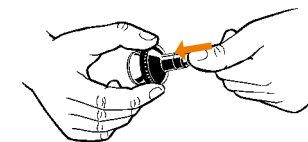

Push the Cap Cylinder out of the Cap Housing

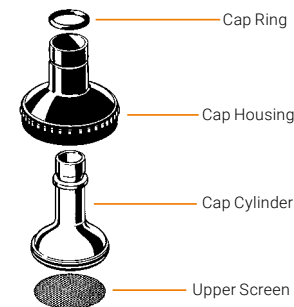

Reassemble in reverse order.

! The upper Screen has to be placed carefully into the intended notch. Non-observance may result in plant particles in the Valve Balloon that might be inhaled subsequently.

9. EASY VALVE

Disassembling the Filling Chamber

Push the lower Screen or the Drip Pad upwards out of the Filling Chamber Cylinder. Push the Filling Chamber Cylinder upwards out of the Filling Chamber Housing.

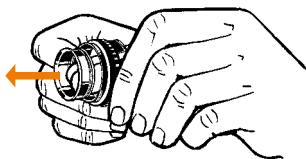

Push the Filling Chamber Cylinder upwards out of the Filling Chamber Housing

When the Filling Chamber Cylinder is pushed out, the three Filling Chamber Clips are loosened and fall out of the Filling Chamber Housing.

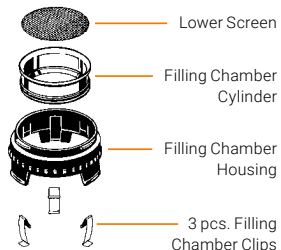

Assembling the Filling Chamber

Push the Filling Chamber Cylinder from above into the Filling Chamber Housing and allow it to lock in place.

Insert the Filling Chamber Clips in the openings provided for them in the foot of the Filling Chamber Housing.

Make sure the Filling Chamber Clips are placed properly, as shown in the illustration.

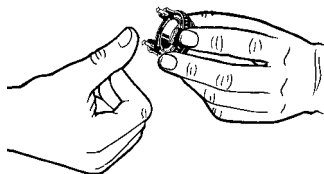
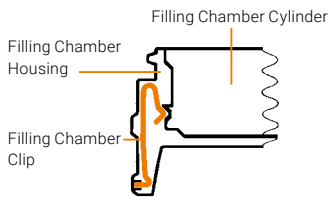

Insert Filling Chamber Clips

Insert the Screen or the Drip Pad into the Filling Chamber from above. Screw Filling Chamber Cap on Filling Chamber.

9. EASY VALVE

9.3. Accessories

9.3.1. Filling Chamber Reducer

 Suitable for vaporizing small amounts of plant material, is the Filling Chamber Reducer, which is available as an accessory, along with the Dosing Capsules. For vaporizing small amounts of aromatic oils, the small Drip Pad is to be used additionally.

The Filling Chamber Reducer is inserted instead of the Filling Chamber Cylinder (see Chapters "Disassembling the Filling Chamber" and "Assembling the Filling Chamber", page 28 onwards).

Filling the Filling Chamber Reducer with ground Plant Material

The Filling Chamber Reducer can be filled with ground plant material directly. Dosing Capsules containing ground plant material can be inserted into the Filling Chamber Reducer as well.

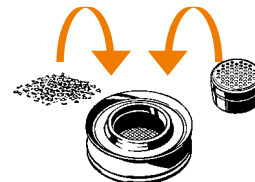

Fill the Filling Chamber Reducer with ground plant material directly or with a filled Dosing Capsule

Filling the Filling Chamber Reducer with aromatic Oils

Either the small Drip Pad (measurements 15 x 5 mm / 0.6 x 0.2 inch) or the Dosing Capsule containing a Drip Pad (measurements 13 x 6 mm / 0.5 x 0.2 inch) are to be inserted into the Filling Chamber Reducer.

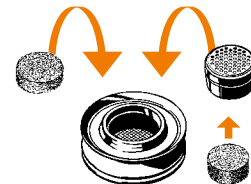

Insert either a small Drip Pad directly into the Filling Chamber Reducer or a Dosing Capsule equipped with a Drip Pad



Please make sure to not overfill the Drip Pad. It can contain up to 5 drops.



For details on how to use the Drip Pad, please refer to Chapter 12. "Drip Pad", page 45.

9. EASY VALVE

9.3.2. Dosing Capsules and Magazine

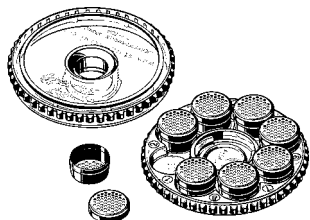

Dosing Capsules with Magazine

With the Dosing Capsules, which are available as accessories, you can fill ground plant material or aromatic oils using the Drip Pads into the Dosing Capsules in advance and store them in the Magazine. This facilitates the handling.

Filling the Dosing Capsules with ground Plant Material

The plant material has to be ground with the included Herb Mill first.

The Dosing Capsules can be filled with ground plant material per Capsule and be stored in the Magazine as a reserve.



Dosing Capsule with removed cap

Grind the plant material and fill the Dosing Capsule by using the Magazine Cap (funnel).

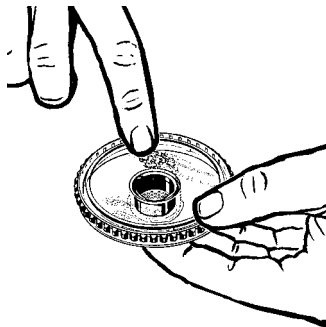

Dosing Capsule while being filled with Magazine Cap (funnel)

Attach the cap onto the Dosing Capsule. Repeat the filling process until the desired amount of Dosing Capsules is filled and insert them into the Magazine. The Magazine can hold up to 8 Dosing Capsules.

9. EASY VALVE

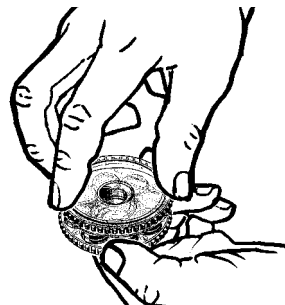

Attaching the Magazine Cap

After filing the Dosing Capsules, attach the Magazine Cap and close it by turning it clockwise.

Filling the Dosing Capsules with aromatic Oils

The Dosing Capsules with inserted Drip Pad, which are available as accessories, can be filled with aromatic oils and store them in the Magazine.



Dosing Capsule with removed cap and inserted Drip Pad



Please make sure to not overfill the Drip Pad. It can contain up to 5 drops.



For details on how to use the Drip Pad, please refer to Chapter 12. "Drip Pad", page 45.

Attach the cap onto the Dosing Capsule. Repeat the filling process until the desired amount of Dosing Capsules is filled and insert them into the Magazine. The Magazine can hold up to 8 Dosing Capsules.

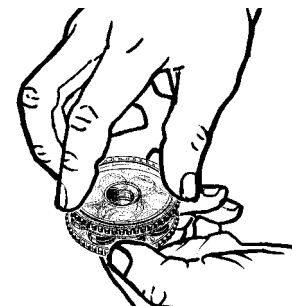

Attaching the Magazine Cap

After filing the Dosing Capsules, attach the Magazine Cap and close it by turning it clockwise.

Inserting the Dosing Capsules

First, the Filling Chamber Reducer, that is available as an accessory as well, is to be inserted instead of the Filling Chamber Cylinder (see Chapters "Disassembling the Filling Chamber" and "Assembling the Filling Chamber", page 28 onwards), afterwards, insert the Dosing Capsules into the Filling Chamber Reducer.



The Dosing Capsule inserted into the Filling Chamber Reducer

Next screw on the Filling Chamber Cap again.



Screw on Filling Chamber Cap

The Filling Chamber Reducer can be filled directly as well (without a Dosing Capsule), see Chapter 9.3.1. "Filling Chamber Reducer", page 29.

9.3.3. Disposable Lip Piece for Hygienic Use

The Lip Piece, which is available as an accessory, will be delivered brand new and in a low-germ, but not fully-sterile state.



The Lip Piece is equipped with a check valve. This check valve reduces the danger of a potential contamination inside the Valve Balloon by preventing breathing into the Valve Balloon.

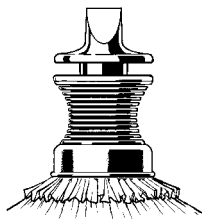

Valve Balloon with Mouthpiece and Lip Piece

The Lip Piece is put on the Mouthpiece, slid until stop and is then ready for operation. The Valve Balloon with Mouthpiece and the Lip Piece may be used by only one person.

A Lip Piece may be used for max. 4 hours after initial operation if it is undamaged and clean. Afterwards, it must be disposed of in the household waste and a new Lip Piece must be used due to hygienic reasons.

Every further use beyond this or the use of damaged and/or contaminated products respectively is the user's responsibility.

We assume no liability if this recommendation is ignored.



Please note that damaged or brittle Lip Pieces are not to be used.

10. SOLID VALVE

10.1. Application and Operation

 The Balloon Material must be kept out of the reach of children as it is a potential source of danger. As an alternative to the VOLCANO Balloon, only use heat-resistant, food safe and odor-free oven tubes and oven bags.

Filling the Filling Chamber

Remove the entire Filling Chamber Insert and fill the Chamber with the desired amount of ground plant material.

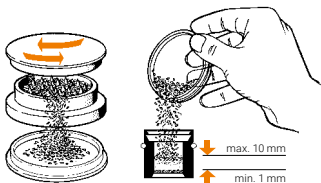

Fill Filling Chamber

Fit in the Filling Chamber Insert and use the pin to lower the Screen Unit so that the content of the Filling Chamber is loosely fixed between the Screens.

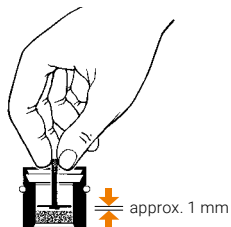

Insert Filling Chamber Insert

Make sure that the Filling Chamber Disc sits properly in the Filling Chamber. It must touch the top edge of the Filling Chamber Cylinder made of stainless steel.

 Take care that the Screens are not obstructed with plant material. To guarantee optimal results, we recommend to clean the Screens after each vaporization cycle with the enclosed Cleaning Brush.

Put the Filling Chamber on the hot air outlet of the Hot Air Generator. Switch on the air pump. To do so, press the green button/switch labeled "AIR". The Filling Chamber as well as the vaporization material must be preheated for a couple of seconds before the aromas and fragrances will start to vaporize.

10. SOLID VALVE

approx. 5 sec



Preheat plant material for a few seconds

 Before putting the Valve Balloon on the Filling Chamber, stretch it so that it extends vertically from the Hot Air Generator when it is filled.

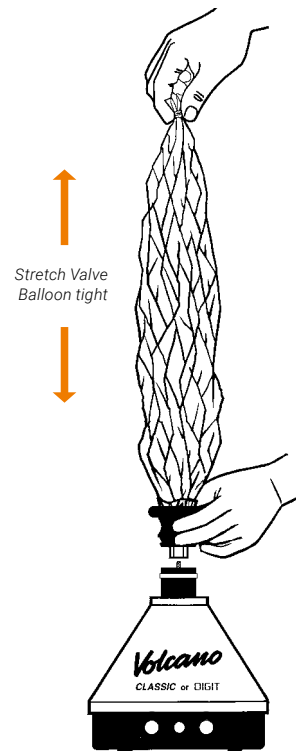

Stretch Valve Balloon tight

10. SOLID VALVE

Attach the Valve with the affixed Balloon to the Filling Chamber. To do this, set the Valve onto the Filling Chamber from above until both grippers are locked in place. The Valve will automatically open up. The Valve Balloon will slowly fill with vapor.

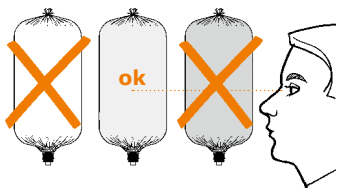

Watch vapor density

When the Valve Balloon is filled, switch off the air pump and remove the Valve Balloon with Filling Chamber. Grasp the Valve firmly with your thumb and index finger at the designated grip indentation.



Attach Valve Balloon to Filling Chamber

Only fill the Valve Balloon with the approximate amount of vapor that you intend to use within the next 10 minutes. Do not overfill the Valve Balloon (overpressure) in order to prevent the loss of vapor. It is important to watch the vapor density in the Valve Balloon (see Chapter 5. "Factors influencing Vaporization", page 14).

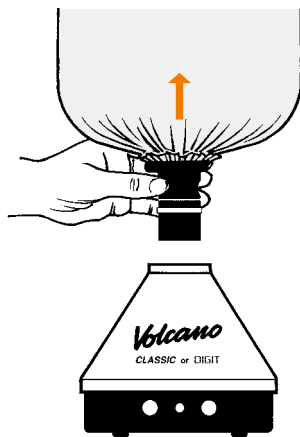

Remove Valve Balloon with Filling Chamber

10. SOLID VALVE

Place the Filling Chamber on a heat-proof surface, for example these Instructions for Use, and detach the Valve Balloon from the Filling Chamber by pressing the grippers together. The Valve closes automatically so that the vapors in the Valve Balloon cannot escape.



Caution! Hot surface!

Never leave Filling Chamber on VOLCANO

Attach the Mouthpiece to the Valve Balloon. Make sure that both grippers are locked in place.

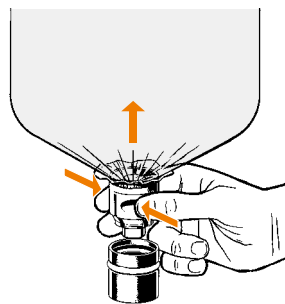

Detach Valve Balloon from Filling Chamber



Caution! Hot surface!

Do not touch any components of the Filling Chamber (except at the textured grip) until they have cooled down after the Valve Balloon has been filled.



Do not leave the Filling Chamber on top of the hot air outlet of the VOLCANO when "HEAT" is switched on, except for filling the Valve Balloon. Non-observance can lead to an overheated Filling Chamber, which might burn one's fingers.

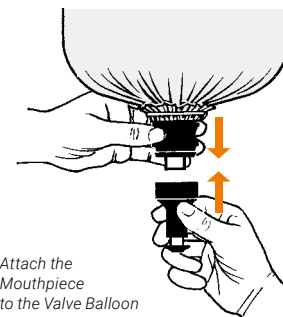

Attach the Mouthpiece to the Valve Balloon

To inhale, put the Mouthpiece to your lips and press them lightly against the Mouthpiece. By doing so, the Valve opens and the vapors can be inhaled from the Valve Balloon. As soon as you remove the pressure from the Mouthpiece, the Valve automatically closes.

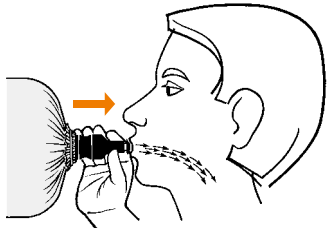

Press Mouthpiece against lips and inhale slowly and evenly for several seconds

! As the content of the Valve Balloon deflates, it may be completely emptied by stretching the Balloon taut and subsequently inhaling the content.

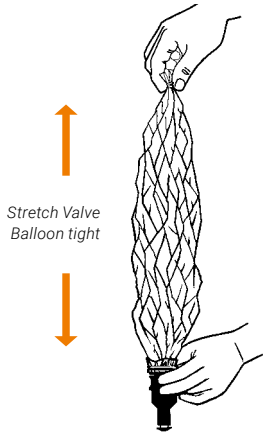

10.2. Cleaning and Maintenance

Mouthpiece, Valve and Filling Chamber

For hygienic reasons, the SOLID VALVE component parts (Valve Balloon with Mouthpiece and Filling Chamber) should be cleaned at least once every two weeks. To prevent any transfer of infectious germs, the Valve Balloon and Mouthpiece should be used only by one person, and not shared by multiple individuals. The component parts should be cleaned regularly to guarantee proper functioning and a clean taste. For hygienic reasons, a thorough cleaning is required whenever the SOLID VALVE is to be used by another individual.

The Balloon should be replaced whenever the Valve is cleaned. For manual cleaning use rubbing alcohol with paper or cotton towels or dishwashing liquid with warm water.



Manual cleaning with alcohol (min. 90%)

The Mouthpiece, Valve and Filling Chamber are easily disassembled within seconds for cleaning. The component parts of the Mouthpiece, Valve and Filling Chamber may also be cleaned in a dishwasher. The Screens and the component parts of the Filling Chamber Insert are too small for that and might get lost in a dishwasher. Before assembling allow all component parts to dry properly.

! Do not immerse any plastic components in ethanol or alcohol for longer than an hour. Extended contact with ethanol or alcohol may lead to discoloration or embrittlement of plastic parts.

After cleaning, check all component parts for surface damage, tears, softening or hardening, impurities, distortion and discoloration and set damaged component parts aside.

Disassembling the Mouthpiece

Pull off the Lip Piece from the Mouthpiece Cylinder and remove the Cylinder from the Mouthpiece Housing.

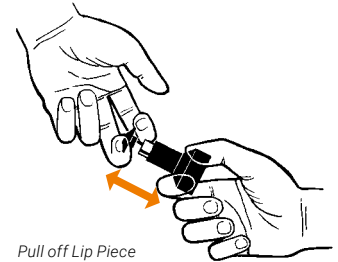

Pull off Lip Piece

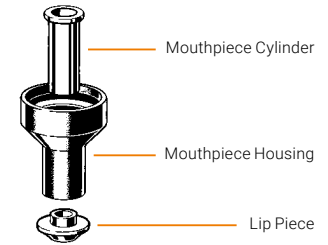

Reassemble in reverse order.

10. SOLID VALVE

Disassembling the Valve

Undo the Slipping and remove the Valve Balloon along with the Balloon Fixation Ring. Insert your index finger into the open end of the Valve Cylinder. Push up the Valve Cylinder until you can unscrew the Valve Cap.



Opening the Slipping

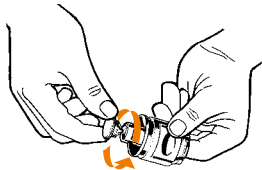

Screw off Valve Cap

Remove the Valve Cap and Valve Ring. Pull out the Valve Cylinder along with the Valve Spring of the Valve Housing. In case of stiffness, the component parts can be loosened by warming them up in warm water.

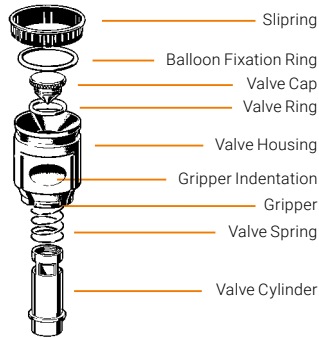

Reassemble in reverse order.

10. SOLID VALVE

Disassembling the Filling Chamber Insert

The Filling Chamber Insert can be easily removed from the Filling Chamber. The Filling Chamber Insert can be disassembled by screwing off the hex nut.



Disassembling the Filling Chamber Insert

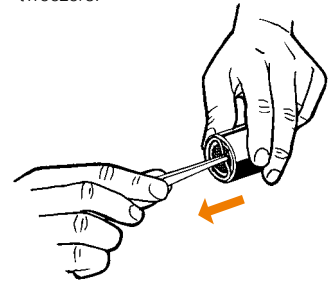

Pull off Filling Chamber Ring with tweezers

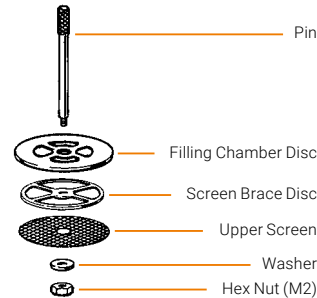

Reassemble in reverse order.

10. SOLID VALVE

Filling Chamber Housing and Filling Chamber Cylinder can be screwed off now. In case of stiffness, the component parts can be loosened by warming them up in warm water.

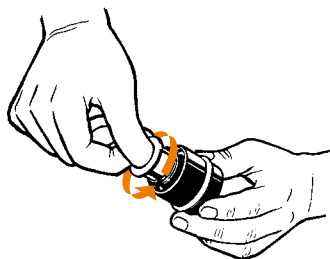

Screw off Filling Chamber Housing from Filling Chamber Cylinder

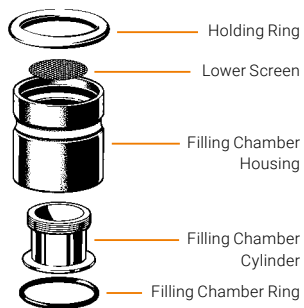

Reassemble in reverse order.

11. ATTACHMENT TO THE EASY VALVE WITH BALLOON ADAPTER RESP. SOLID VALVE

As an alternative to the VOLCANO Balloon, use an odor-free, heat-resistant and food safe oven tube or oven bag, which is used in the food industry. It is available in nearly every drug store and supermarket. Do not use any other plastic bags or clingwraps. The procedure to change a Balloon with a heat-proof oven tube is described below:

Cut a piece of approx. 50-60 cm (19-23 inch) and tie it close at one end.

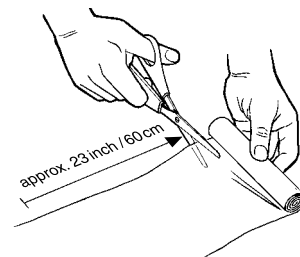

Cut a piece of approx. 50-60 cm (19-23 inch)

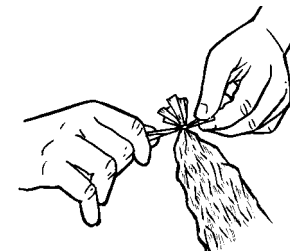

Tie close at one end

As the opening of the Balloon is much wider than the diameter of the Valve Housing, the Balloon must be folded. To do this pull the Balloon Fixation Ring approximately 3 cm (1.2 inch) over the open end of the Balloon and then pull the Balloon Fixation Ring with the Balloon over the Valve Collar until it fits into the intended notch.

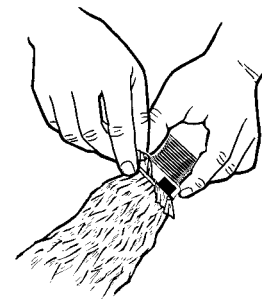

Attach Balloon to Valve

11. ATTACHMENT TO THE EASY VALVE WITH BALLOON ADAPTER RESP. SOLID VALVE

Adjust the folds equally around the Valve Collar making certain that the Valve hangs straight down when the Balloon is held at the end.

Bend the protruding end of the Balloon back. Secure the Balloon by pulling the Slipring over both the Valve and the Balloon Fixation Ring so that the Balloon Fixation Ring is no longer visible and the protruding end of the Balloon points backwards.

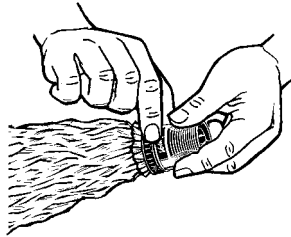

Fixing the Balloon with the Slipring

If needed, the extending collar can be trimmed away using a pair of scissors, making certain not to poke a hole into the Balloon.

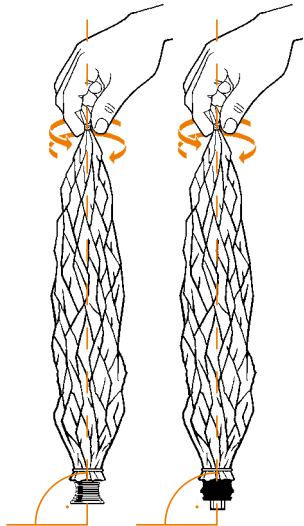

Align Valve Balloon to Valve

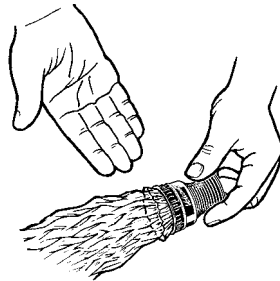

Valve Balloon ready to use



Balloon Sets may be ordered from www.storz-bickel.com.

12. DRIP PAD

The Drip Pad is used to vaporize the extracts (aromatic oils) of the plants specified in the plant list. The stainless steel wire of the Drip Pad serves as the carrier of the extract, comparable to the unvaporizable plant fibers in vaporization plant material.



Caution! The extracts are usually concentrates; therefore, a very small dosage is sufficient. The vaporized concentrates may not be inhaled directly, but instead pumping them into the room air directly from the Filling Chamber without the Valve Balloon attached.

12.1. Preparation

If the Drip Pad is used, the Screens in the Filling Chamber are not required and should be removed. This applies to the Filling Chamber of the EASY VALVE as well as to the Filling Chamber of the SOLID VALVE. In both cases the Drip Pad is inserted in place of the lower Screen in the Filling Chamber. You will need the Filling Chamber Disc of the SOLID VALVE as this Valve cannot open without the Filling Chamber Disc.



Preparation to use the Drip Pad

12.2. Application

Turn the Filling Chamber upside down and use a pipette to drop the extract onto the center of the bottom of the Drip Pad. The Drip Pad can hold up to 10 drops. If you use an extract with unknown concentration, use maximum one drop and carefully increase the amount until you achieve the correct dosage.

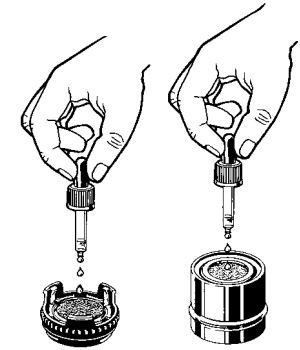

Applying drops with a pipette



Please note that oils become more liquid at high temperatures. If you use too many drops, the extract could drip into the Hot Air Generator, which must be avoided.

12. DRIP PAD

Certain extracts may be provided in a diluted form as alcoholic solutions. The advantage of such extracts is that the liquid is distributed more evenly around the stainless steel wire of the Drip Pad. Therefore, the surface used for vaporization is larger. However, if such extracts are used, first the alcohol must be separated from the extract as alcohol should not be inhaled. To do this, put the Filling Chamber onto the unheated (room temperature) VOLCANO and switch on the air pump until the alcohol has evaporated, which may take a few seconds. As alcohol has a characteristic odor, a simple smell test can be performed to find out whether the Filling Chamber is free of alcohol. The extracts that vaporize only at higher temperatures remain in the Drip Pad. Then heat up the VOLCANO and vaporize the extract left on the Drip Pad as described in the chapters EASY VALVE and SOLID VALVE, pages 23 and 34. Extracts without solvents can be vaporized directly after they are applied to the Drip Pad.

12.3. Cleaning

Put the Drip Pad in rubbing alcohol and rinse it thoroughly. As the Drip Pad is made of stainless steel, it can be used again and again if it is cleaned well.

13. TECHNICAL SPECIFICATIONS

Voltage: 220-240 V / 50-60 Hz or 110-120 V / 50-60 Hz.

The voltage specification is located on the bottom side of the VOLCANO Hot Air Generator.

Heat output: 100 W

Air pump output: 11 W

Vaporization temperature:

CLASSIC adjustable between approx. 130°C-230°C (266°F-446°F);
DIGIT adjustable between approx. 40°C-230°C (104°F-446°F)

Air flow: approx. 12 l/min

Size: CLASSIC and DIGIT 20.0 x 18.0 cm (7.9 x 7.1 inch)

Weight:

CLASSIC approx. 1.6 kg (3.5 lb);
DIGIT approx. 1.8 kg (4.0 lb)

Safety category I (electrically grounded)

Please unplug to disconnect from the mains current.

Subject to technical changes.

Patents and designs:

www.storz-bickel.com/patents

Manufacturer:

Storz & Bickel GmbH & Co. KG
In Grubenäcker 5-9
78532 Tuttlingen, Germany

14. CE DECLARATION OF CONFORMITY

The devices comply with the following EC Directives:

- Low Voltage Directive 73/23/EWG
- Electromagnetic Compatibility 89/336/EWG

15.1. Warranty

Storz & Bickel GmbH & Co. KG and Storz & Bickel America Inc. as seller hereby guarantee the customer that the product will be free from defects in accordance with the specifications of German law, and pursuant to our General Terms and Conditions (GTC), upon which the purchasing agreement are based. In addition, we guarantee that our product VOLCANO will be free from defects for a period of three years. Of course, Storz & Bickel will only be subject to a warranty obligation if the customer has purchased the products directly from us. If products are purchased from third parties, warranty claims may only be asserted against these third parties, and Storz & Bickel cannot provide any information on the content of such claims.

In clarification, we would like to note once again here that the warranty extends only to correcting such initial defects that exist despite proper handling of the product in consideration of this Instructions for Use and further information provided to users. Normal wear or tear to the products is not considered a defect under warranty law. If the customer has commissioned third parties with completing maintenance or repair of the product, or if the customer uses external products, Storz & Bickel's warranty obligations will only exist if the customer can prove that the

defect was not caused by use of the external service or external product.

Storz & Bickel will decide at its own discretion whether to correct a defect covered to warranty law through repair or by delivering a new product to the customer.

Any warranty claims must be directed to Storz & Bickel GmbH, In Grubenäcker 5-9, 78532 Tuttlingen. American and Canadian customers should direct warranty claims to Storz & Bickel America Inc., 1078 60th Street, Suite A, Oakland, CA 94608. Please send the complete defective item to us, not disassembled, with invoice. Please use external packaging that would prevent any damage during transportation.

In order to avoid misunderstandings, we would like to note that all information on our products provided in this Instructions for Use or elsewhere does not represent any guarantee of features or durability, unless we have expressly referred to a guarantee for such features or durability.

15.2. Liability

Storz & Bickel shall be liable for any damages caused to the customer by our products in accordance with German law and pursuant to our GTC. Under said provisions, we are only liable for damages caused by intentional action or gross negligence, unless

such damages involve death, personal injury, or injury to health, or if the injury is related to a cardinal contractual obligation. In such cases, we will also be liable to the customer for simple negligence.

15.3. Repair Service

In addition to our warranty obligations, we offer competent repair service to our customers. We will promptly repair any defective products made by us after we have informed the customer of estimated costs and obtained customer approval.

15.4. Copyright

This document is copyright protected, and may not be used either in whole or in part pursuant to Sections 15 et seqq. UrhG (German Copyright Act) without prior written approval of Storz & Bickel.



www.storz-bickel.com

STORZ & BICKEL GMBH & CO. KG

In Grubenäcker 5-9 · 78532 Tuttlingen/Germany

